

REMOVING THE GRILLE

If it is necessary to remove the grille after installation, in order to avoid scratching the grille or frame, you may unfold a paper clip, insert the straight end through one of the holes in the grille, and gently pull up.

NEW CONSTRUCTION

You will need to purchase the CVRIF50 rough-in frame kit. Detailed installation instructions are supplied with the rough-in kit

SPECIFICATIONS

Plate Size (W x H)
10" x 28-1/8" (254mm x 714mm)

Mounting depth
3-7/8" (98mm)

Mounting Cutout Size (W x H)
8-5/8" x 26-13/16" (219mm x 681mm)

Weight with CVSAT50 or CVCEN50 attached
12 lbs (5.5 kg)

All features and specifications are subject to change without notice.

Declaration of Conformity

CE

We, Harman Consumer International
2, route de Tours
72500 Chateau-du-Loir
France

declare in own responsibility that the products described in this owner's manual are in compliance with technical standards:

EN 61000-6-3:2001
EN 61000-6-1:2001

G.M.
Gary Mardell
Harman Consumer International
Chateau-du-Loir, France 4/04



INSTALLATION MANUAL

INCLUDED

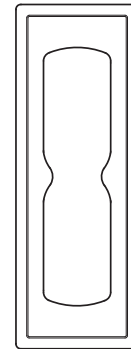

One inwall adaptor frame



One inwall adaptor grille

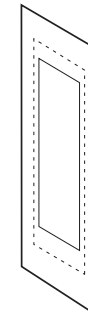

Template/paint shield (punch out at perforation).

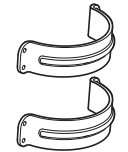

Two speaker attachment braces

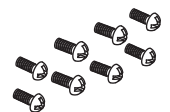

8 small bolts



Self-adhesive JBL logo for placement on metal mesh grille

OWNER'S GUIDE	JBL	PRO SOUND COMES HOME™
PRODUCT LINE: JBL Cinema Vision™	JBL Consumer Products 250 Crossways Park Drive, Woodbury, NY 11797 8500 Balboa Boulevard, Northridge, CA 91328 516.255.4JBL (4525) WWW.jbl.com	
MODEL: CVIW50	NOTE: For new-construction applications, be sure to purchase the CVRIF50 rough-in frame kit.	
	© 2005 Harman International Industries, Incorporated	
	JBL is a registered trademark of Harman International Industries, Incorporated.	
	Part No. 4006 - 000 - 05200.	
	H A Harman International Company	

PAINTING THE CVIW50 FRAME & GRILLE

JBI CVIW50 can be painted to match any decor. If you wish to change its color, the satin finish on the grille and frame will function as a primer coat. If CVIW50 is to be painted, please do it before assembling a CVSAT50 or CVCEN50 onto this adaptor.

Before painting, install the paint shield (in the assembly kit) securely into the recess in the baffle. This will protect the speaker components and baffle from paint residue. Use a high-quality spray paint, and apply a thin coat of color.

Be certain the grille perforations remain free of paint. Filling them with paint will diminish the sound quality.

NOTE: Gently remove the acoustical foam blanket from the grille before painting. Reattach the blanket after the paint has dried.

ASSEMBLING A CVSAT50 OR CVCEN50 ONTO CVIW50

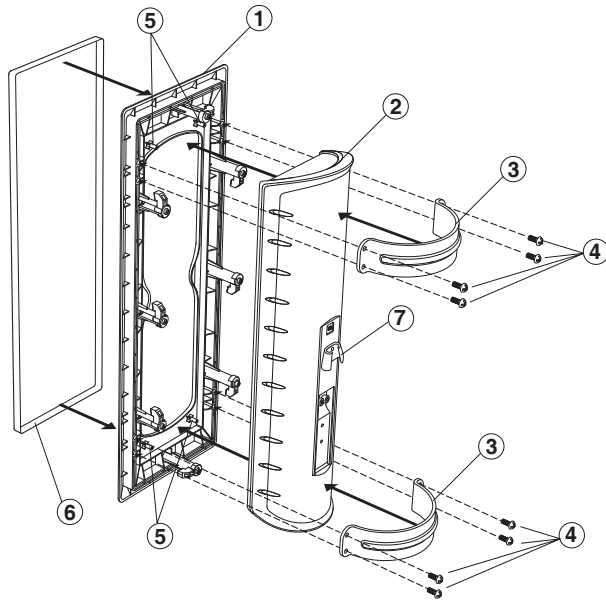

Note: If the CVIW50 frame and/or grille are to be painted, please do it before assembling the loudspeaker onto the CVIW50.

1. Place the frame (1) on a flat surface. Use a non abrasive surface as to not damage the finish of the frame.
2. Position the CVSAT50 or CVCEN50 loudspeaker (2) on the frame (1). The four pins on the CVIW50 frame (5) should be inserted into the four grille-pin holes on the loudspeaker baffle.
3. Position each of the two braces (3) on the back of the loudspeaker (2) enclosure, and securely attach brace (3) to frame (1) using 4 small bolts (4) per frame.
4. Remove mounting bracket (7) and store bracket and screws for possible future use.
5. Do not attach grille (6) until after the assembly is installed in a wall.

INSTALLATION

The JBL Cinema Vision in-wall adaptors were designed to be easily installed. However, if you are unsure of your ability to properly install these assemblies, please contact your dealer or a qualified installer.

Tools Needed

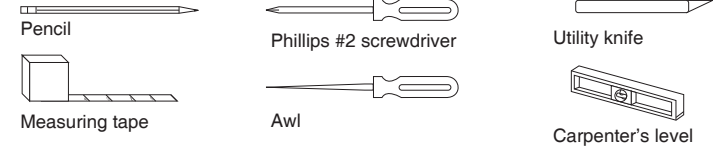

EXISTING CONSTRUCTION

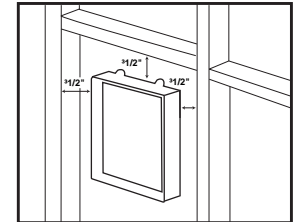
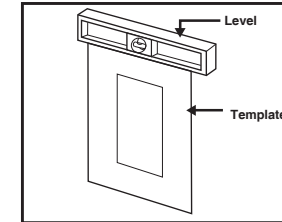

1. Mount CVSAT50 or CVCEN50 loudspeaker to CVIW50 adaptor as instructed earlier in this installation guide.

Determine the correct speaker location. **Note:** Remove the inner template, which is the paint shield, at the perforation. Also remove the other perforation from the cardboard part until you are left with a cardboard frame. Confirm that this cardboard frame comfortably fits on the back of the CVIW50 frame. This will be the opening size of your installation cutout in the drywall. Although the adaptor may be oriented either horizontally or vertically, the installation procedure is the same.

NOTE: always allow at least one-half inch between a wall stud and the speaker cutout or the locking tabs will not be able to swivel into place.

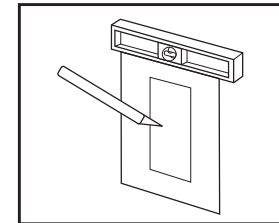

2. Cut the drywall.

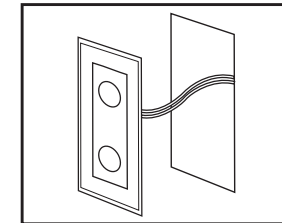

Connect the speaker wires to the speaker.

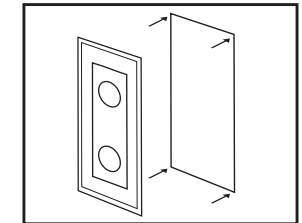

Place the frame assembly in the wall.

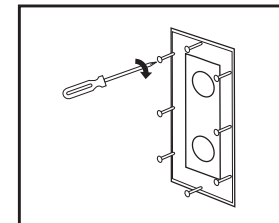

3. Screw down each of the 8 phillips head screws. The locking tabs will swivel into place and will secure the unit to the rear surface of the drywall.

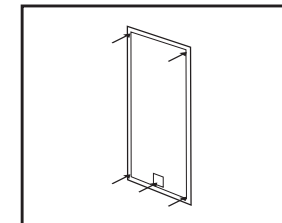

Replace the metal grille. Attach the JBL logo to the grille to correspond to vertical or horizontal installation.